

CATEGORY	DESCRIPTION	P/N #
CONNECTOR	MJ45 SMT 沉板 H=5.5mm 塑胶有破孔	MJ88-BX11-XRVS1

REV.	ECN NO	DESCRIPTION	REVISED	DATE
A01		New Release	XSY	2014.12.25

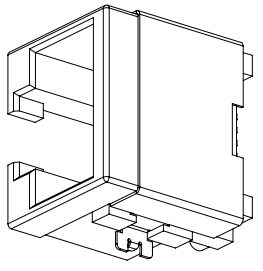

- SPECIFICATIONS:
1. Voltage: 150V AC RMS
 2. Current Rating: 1.5A
 3. Contact Resistance: 40mΩ MAX.
 4. Insulation Resistance: 500MΩ MIN.
 5. Dielectric Withstand Voltage :500V AC
 6. Operate Temperature: -40°C~80°C
 7. Durability: 750 Mating Cycles MIN.

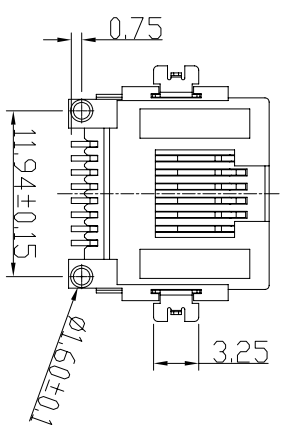
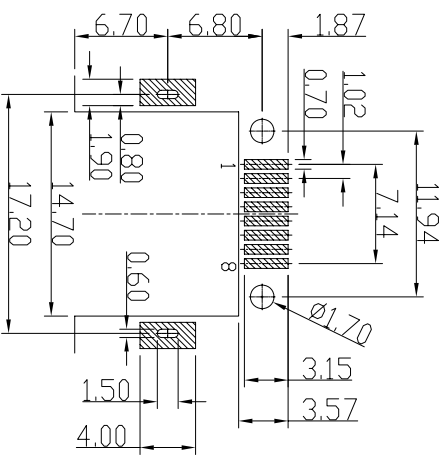
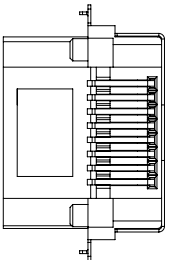
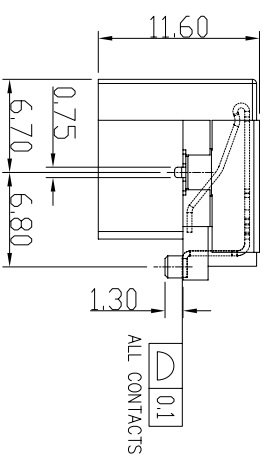
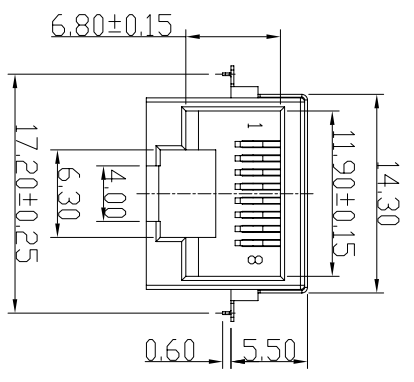
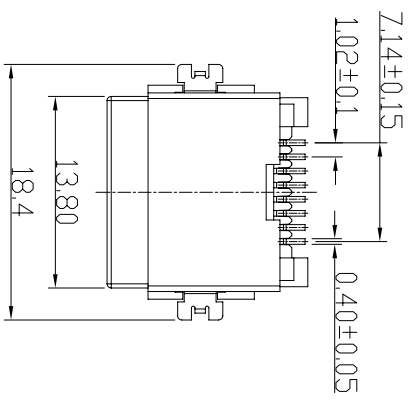

MJ88-BX11-XRVS1

X	Terminal Plating
0	Au 1u" Plating
1	Au 3u" Plating
2	Au 6u" Plating
3	Au 15u" Plating

Recommend PCB Layout
Jack Top View
Tolerance: ±0.05mm

 东莞市合陵电子有限公司
DongGuan Heling Electronic Co.,LTD

UNLESS OTHERWISE SPECIFIED TOLERANCES	SCALE:1/1	UNIT: mm	DWG.NO:
DECIMALS:	SIZE: A3	PAGE:1 OF 1	REV:A01
ANGLES:	APPROVED BY	CHECKED BY	PREPARED BY
X.XX :±0.2	X :±0.5	X.X :±0.3	X.XX :±1*
	DICK	XSY	XSY

NO.	PART NAME	QTY	MATERIAL	PLATING & COLOR	Remark
c	SHELL	1	BRASS T=0.2mm	Ni PALTING	
b	TERMINAL	8	PHOSPHOR BRONZE	Au/Tin PALTING	
a	HOUSING	1	LCP+30%G.F UL94V-0	BLACK	